

NEW UNIT

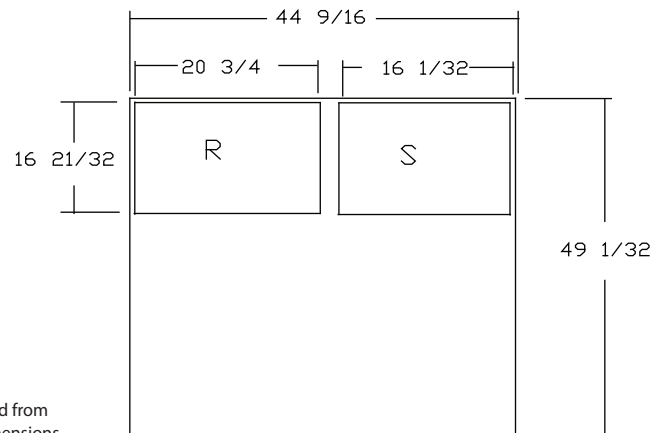

EXISTING UNIT

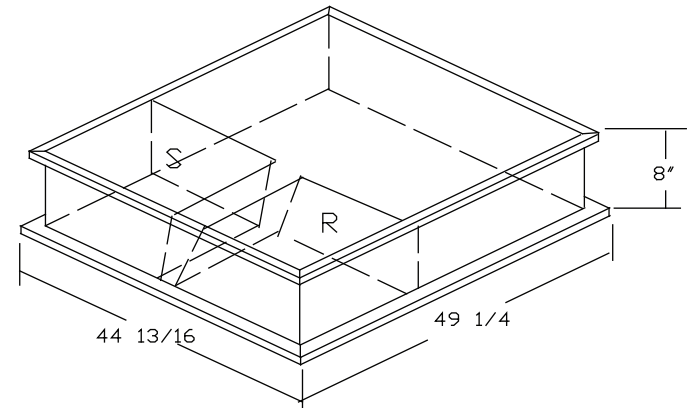

Curb Adapter Information

- 1) These curb adapters have been designed from HVAC unit literature. Actual job site dimensions have not been taken. Field alterations and reinforcements may be required of site dimensions vary from literature.
- 2) Before ordering curb adapter, contractor must confirm that dimensions of existing curb on job site matches dimensions of existing curb on this drawing.
- 3) Before new HVAC unit is set in place inspect structural stability of existing curb and building's roof load capability. Reinforce if required.
- 4) All curb adapters will increase the system's external static pressure and must be included when calculating unit requirements.
- 5) Follow all local and state laws when installing curb adapters.



MODULAR METAL FABRICATORS INC.

CURB ADAPTER

SDRHEEMAD105

	SIZE	FSCM NO.	PART NO.	REV
	SCALE		SHEET	